

Fasad famsida

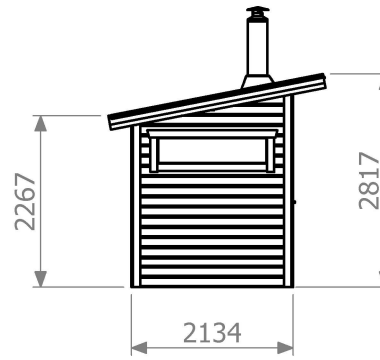

Fasad vänster sida

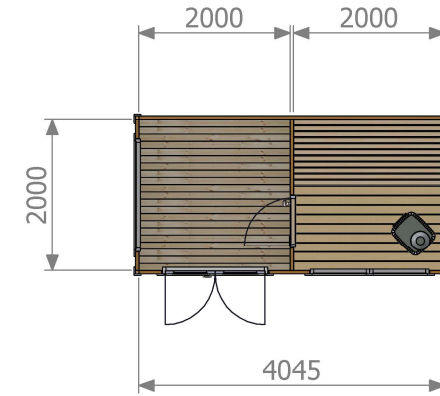

Planritning

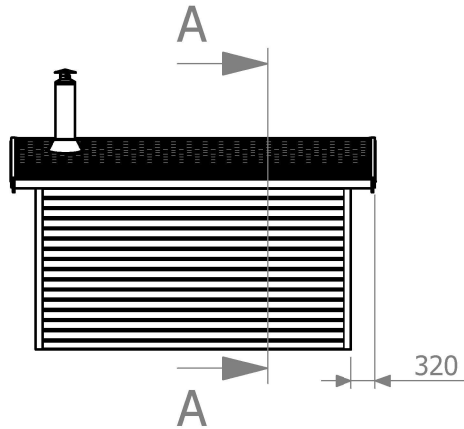

Fasad baksida

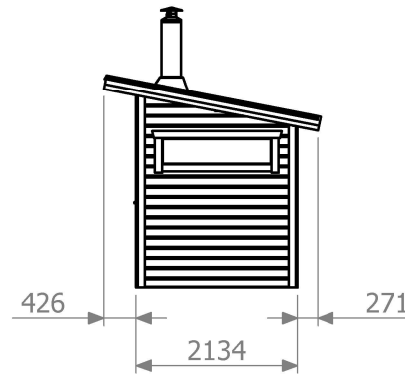

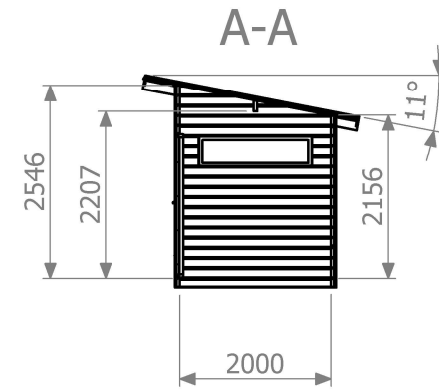

Fasad höger sida

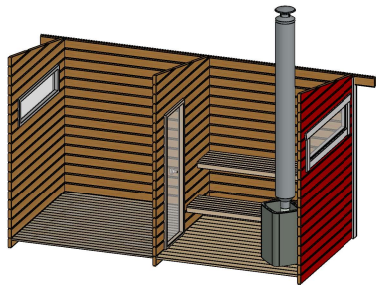

Sektion

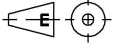

3D-vy

Konstruerad av: <b>JOE</b>	Datum: <b>2024-08-25</b>	Godkänd av:	Check-datum: <b>2024-12-02</b>	Vikt Kg:	Skala: <b>1:100</b>	Format: <b>A4</b>	Blad Nr: <b>1/1</b>
 TRÄBYGGARNA	 Gen. tol: SS-ISO 2768-1 m	Namn: <b>Fasad-, Plan- &amp; Sektionsritning</b>				Art. Nr: _____	
	Generell Ra: 	Bastu Utsikten Pulpet PD 8.5m <sup>2</sup> PD=Pardörr				Kund/Notering: <b>Träbyggarna</b>	
						Ritningsnummer:	Revision: