

Den här handlingen får ej utan vårt medgivande kopieras. Den får ej heller delgivas annan eller eljest behörigheten användas. Överförädlare härav beivras med stöd av gällande lag.

This document must not be copied without our written permission and the contents thereof must not be imported to a third party or be used for any unauthorized purpose.

3D-Part: J:\8\_JESS\3\_Kunder\Träbyggarna\FÖRRÅD\1\_SNICKEBOA\_85\_SAD\_PD\1\_SNICKEBOA\_85\_SAD\_PD\1\_Snickeboa-85-SAD-PD  
 Drawing: J:\8\_JESS\3\_Kunder\Träbyggarna\FÖRRÅD\1\_SNICKEBOA\_85\_SAD\_PD\1\_Snickeboa 85 Komplet

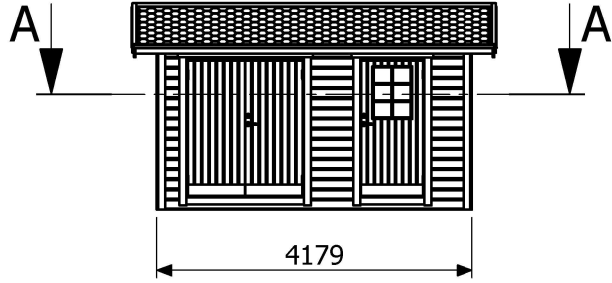

Fasad framsida

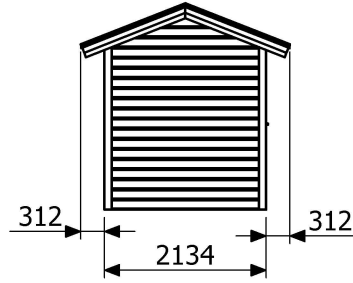

Fasad vänster sida

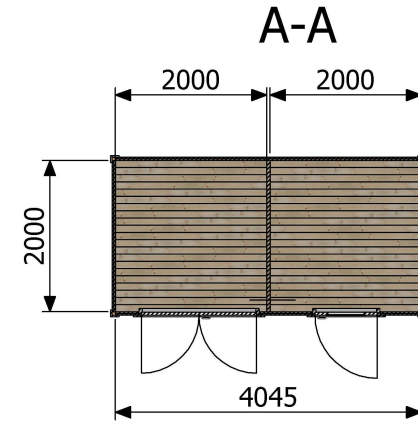

Planritning

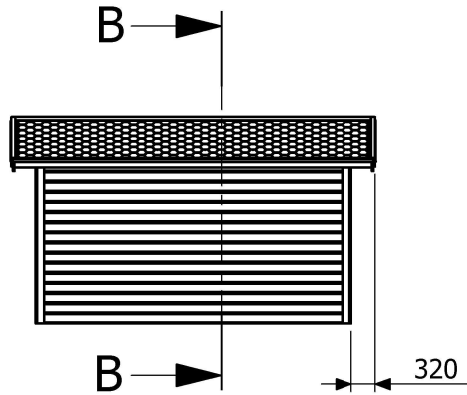

Fasad baksida

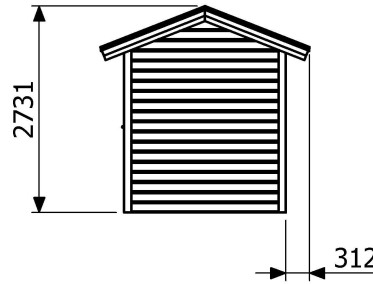

Fasad höger sida

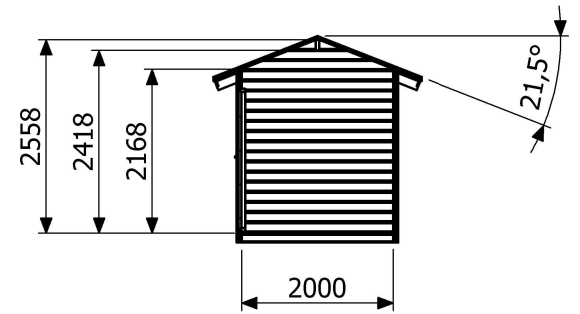

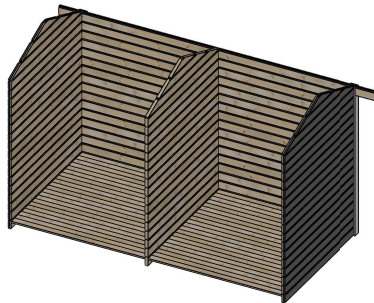

B-B  
Sektion



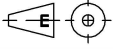

3D-vy inv.

0

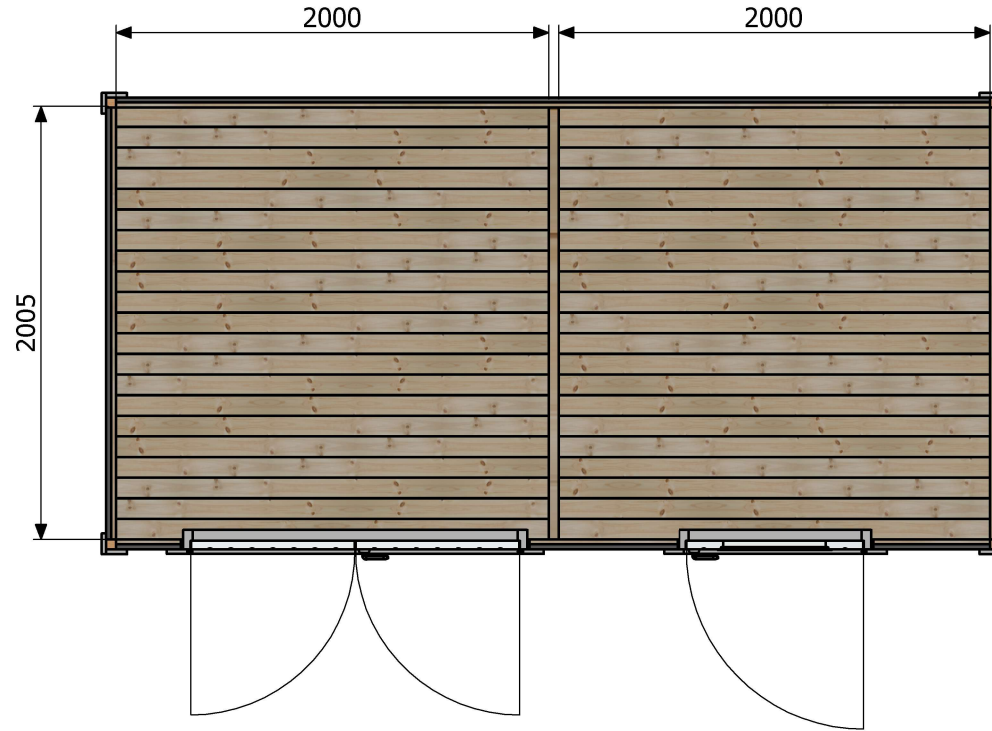
Konstruerad av: <b>JOE</b>	Datum: <b>2026-05-28</b>	Godkänd av:	Check-datum: <b>2026-04-24</b>	Vikt Kg:	Skala: <b>1:100</b>	Format: <b>A4</b>	Blad Nr: <b>1/2</b>
 <b>TRÄBYGGARNA</b>	 Gen. tol: <b>EN ISO 13920-D</b>	Namn: <b>Fasad-, Plan- &amp; Situationsritning</b>				Art. Nr: <b>85-02-SNI-SAD-PD-00</b>	
	Generell Ra: 	Förråd "Snickeboa" 8.5m <sup>2</sup>				Kund/Notering: <b>Träbyggarna</b>	
						Ritningsnummer:	Revision:

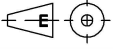

Konstruerad av: <b>JOE</b>	Datum: <b>2026-05-31</b>	Godkänd av:	Check-datum: <b>2026-04-24</b>	Vikt Kg:	Skala: <b>1:35</b>	Format: <b>A4</b>	Blad Nr: <b>2/2</b>	
 TRÄBYGGARNA	 Gen. tol: EN ISO 13920-D	Namn: <b>Planritning</b> Förråd "Snickeboa" 8.5m <sup>2</sup>				Art. Nr: <b>85-02-SNI-SAD-PD-00</b>		
	Generell Ra: 					Kund/Notering: <b>Träbyggarna</b>		
						Ritningsnummer:		Revision: