

Den här handlingen får ej utan vårt medgivande kopieras. Den får ej heller delges, annan eller eljest obehörigen användas. Överträdelse härav beivras med stöd av gällande lag.

This document must not be copied without our written permission and the contents thereof must not be imported to a third party or be used for any unauthorized purpose.

3D-Part: J:\8\_JESS\3\_Kunder\Träbyggarna\FÖRRÅD\Magasinet\1\_Magasinet-120-PUL-PD  
 Drawing: J:\8\_JESS\3\_Kunder\Träbyggarna\FÖRRÅD\Magasinet\1\_Magasinet\_120\_Komplett

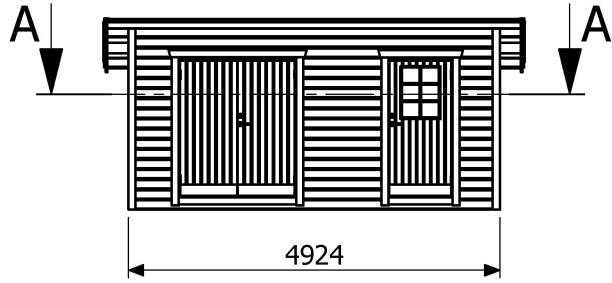

Fasad framsida

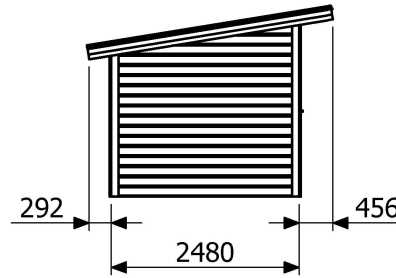

Fasad vänster sida

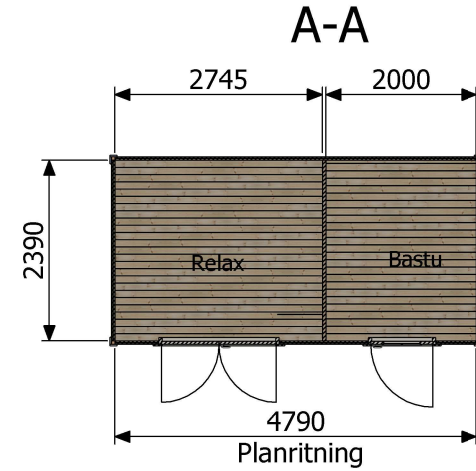

Planritning

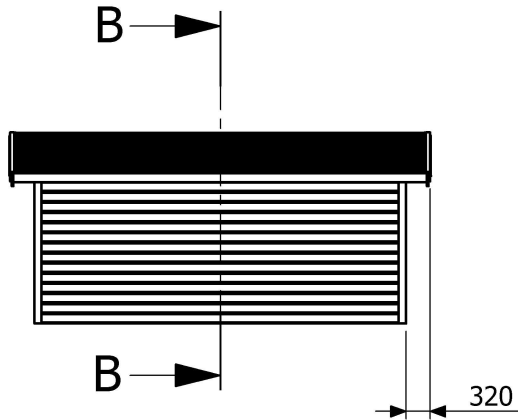

Fasad baksida

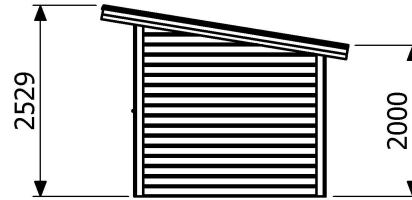

Fasad höger sida

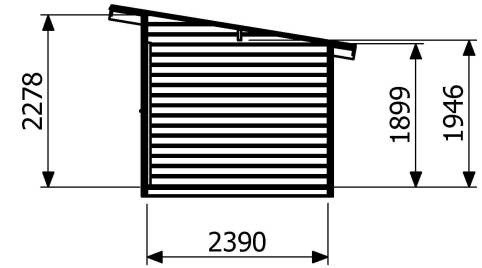

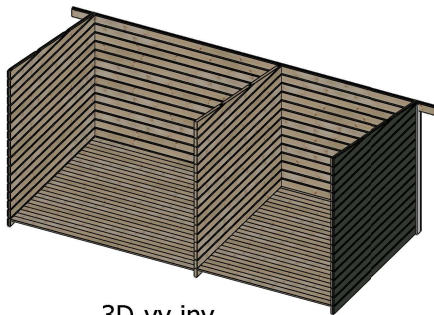

B-B  
Sektion

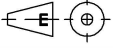

3D-vy inv.

0

Konstruerad av: <b>JOE</b>	Datum: <b>2026-03-30</b>	Godkänd av:	Check-datum: <b>2026-04-24</b>	Vikt Kg:	Skala: <b>1:100</b>	Format: <b>A4</b>	Blad Nr: <b>1/2</b>
 <b>TRÄBYGGARNA</b>	 Gen. tol: <b>EN ISO 13920-D</b>	Namn: <b>Fasad-, Plan- &amp; Situationsritning</b>				Art. Nr: <b>120-02-MAG-PUL-PD-00</b>	
	Generell Ra: 	Förråd "Magasinet" 12m <sup>2</sup>				Kund/Notering: <b>Träbyggarna</b>	
						Ritningsnummer:	Revision: