

Fasad famsida

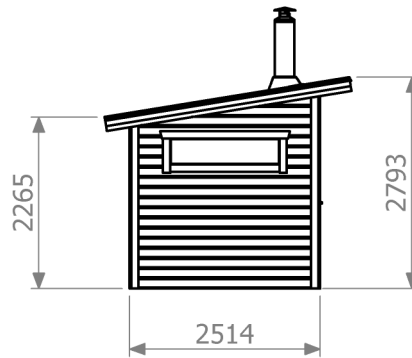

Fasad vänster sida

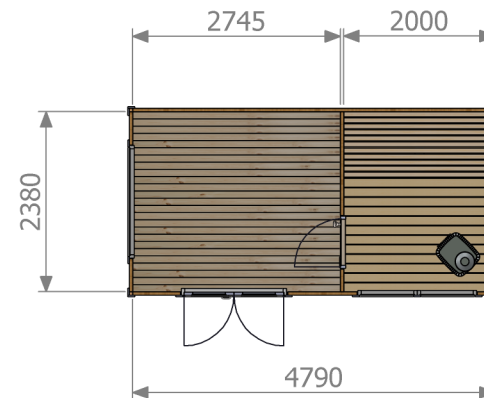

Planritning

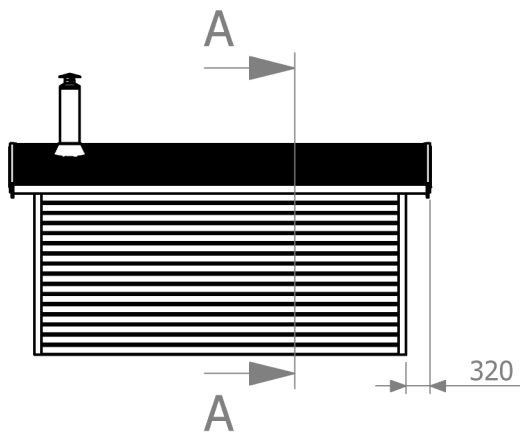

Fasad baksida

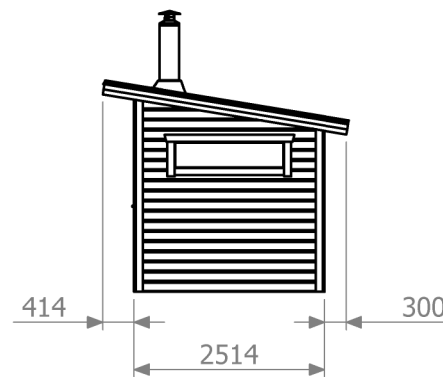

Fasad höger sida

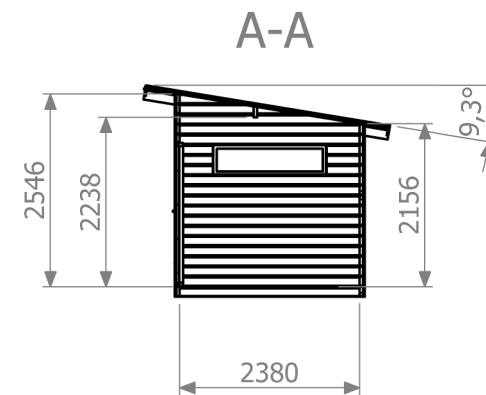

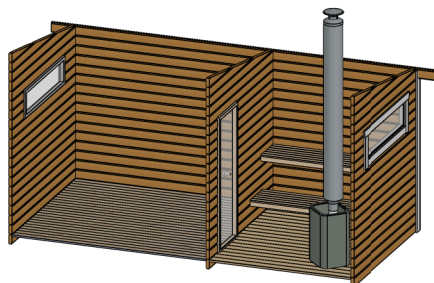

Sektion



3D-vy

Denna handling får ej utan vårt medgivande kopieras. Den får ej heller delgivas annan eller eljest obehörigheten användas. Överförälske hindrar bekrävas med stöd av gällande lag.
 This document must not be copied without our written permission and the contents there of must not be imparted to a third party or be used for any unauthorized purpose.

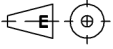
3D-Part: J:\8_JESS\3_Kunder\Träbyggarna\STUGOR\Utsikten Pulpettak\1_Utsikten PD120 Pulpet Komplet
 Drawing: J:\8_JESS\3_Kunder\Träbyggarna\STUGOR\Utsikten Pulpettak\1_Utsikten PD120 Pulpet Komplet

Konstruerad av: JOE	Datum: 2024-12-09	Godkänd av:	Check-datum: 2024-12-16	Vikt Kg:	Skala: 1:100	Format: A4	Blad Nr: 1/1
 TRÄBYGGARNA	 Gen. tol: SS-ISO 2768-1 m	Namn: Fasad-, Plan- & Situationsritning				Art. Nr: Kund/Notering: Träbyggarna	
	Generell Ra: 	Bastustuga Utsikten Funkis PD 12m² Pardörr				Ritningsnummer: Revision:	