

Denne handling får ej, utan vårt medgivande kopieras. Den får ej heller delgävas annan eller eljest obehörigheten användas. Överföradelse härav, beivras med stöd av gällande lag.

This document must not be copied without our written permission and the contents thereof must not be imported to a third party or be used for any unauthorized purpose.

3D-Part: J:\8_JESS\3_Kunder\Träbyggarna\STUGOR\Funkis\1_Funkis 40ED Komplet
 Drawing: J:\8_JESS\3_Kunder\Träbyggarna\STUGOR\Funkis\1_Funkis 40ED Komplet

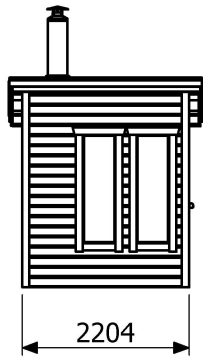

Fasad famsida

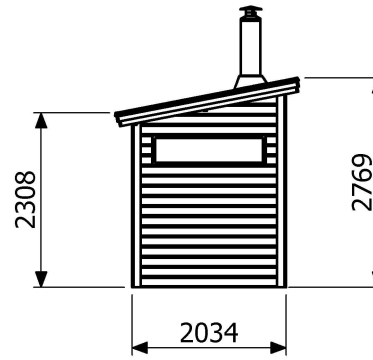

Fasad vänster sida

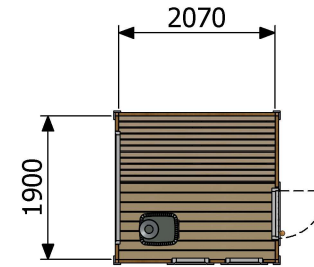

Planritning

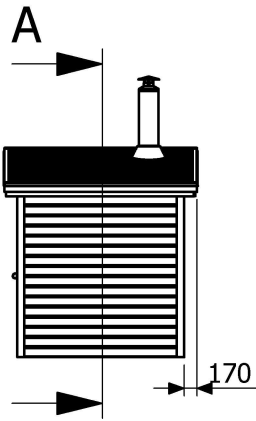

Fasad baksida

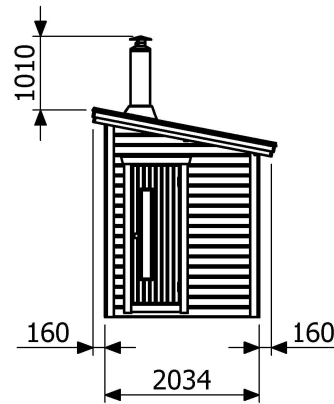

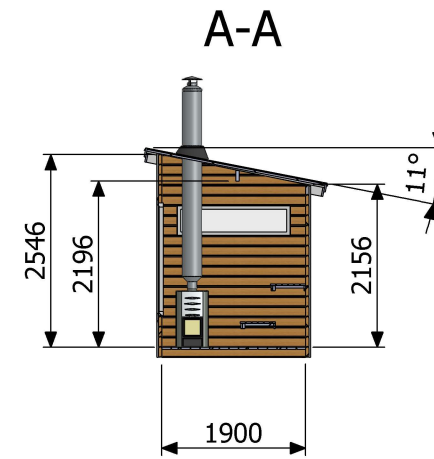

Fasad höger sida

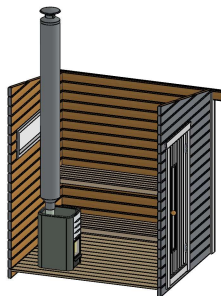

Sektion

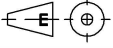

3D-vy

Konstruerad av: JOE	Datum: 2025-03-26	Godkänd av:	Check-datum: 2025-04-04	Vikt Kg:	Skala: 1:100	Format: A4	Blad Nr: 1/1
 TRÄBYGGARNA	 Gen. tol: SS-ISO 2768-1 m	Namn: Fasad-, Plan- & Sektionsritning				Art. Nr:	
	Generell Ra: 	Bastu Funkis 4m²				Kund/Notering: Träbyggarna	
						Ritningsnummer:	Revision: